

Controller housing

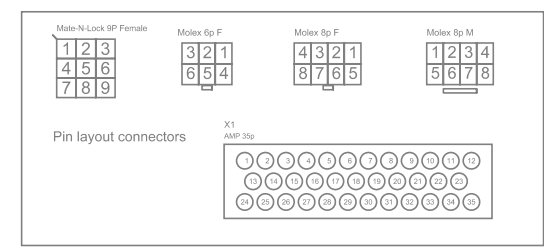

Remarks:

- All power cables should be kept short and were possible run parallel.
- All signal cables should be shielded.
- Only use double insulated power cables.
- Do not exceed recommended fuses en fuse types.
- Main fuses should be installed within 3 metre. from battery
- Do not install fuses in battery compartments

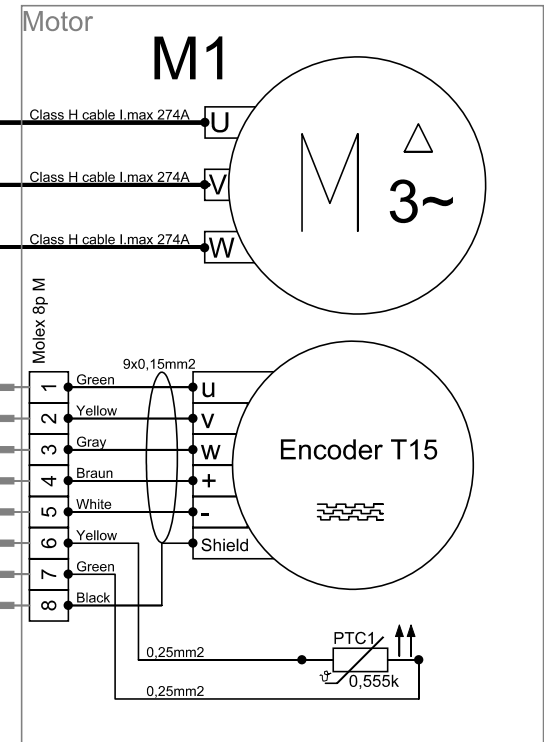
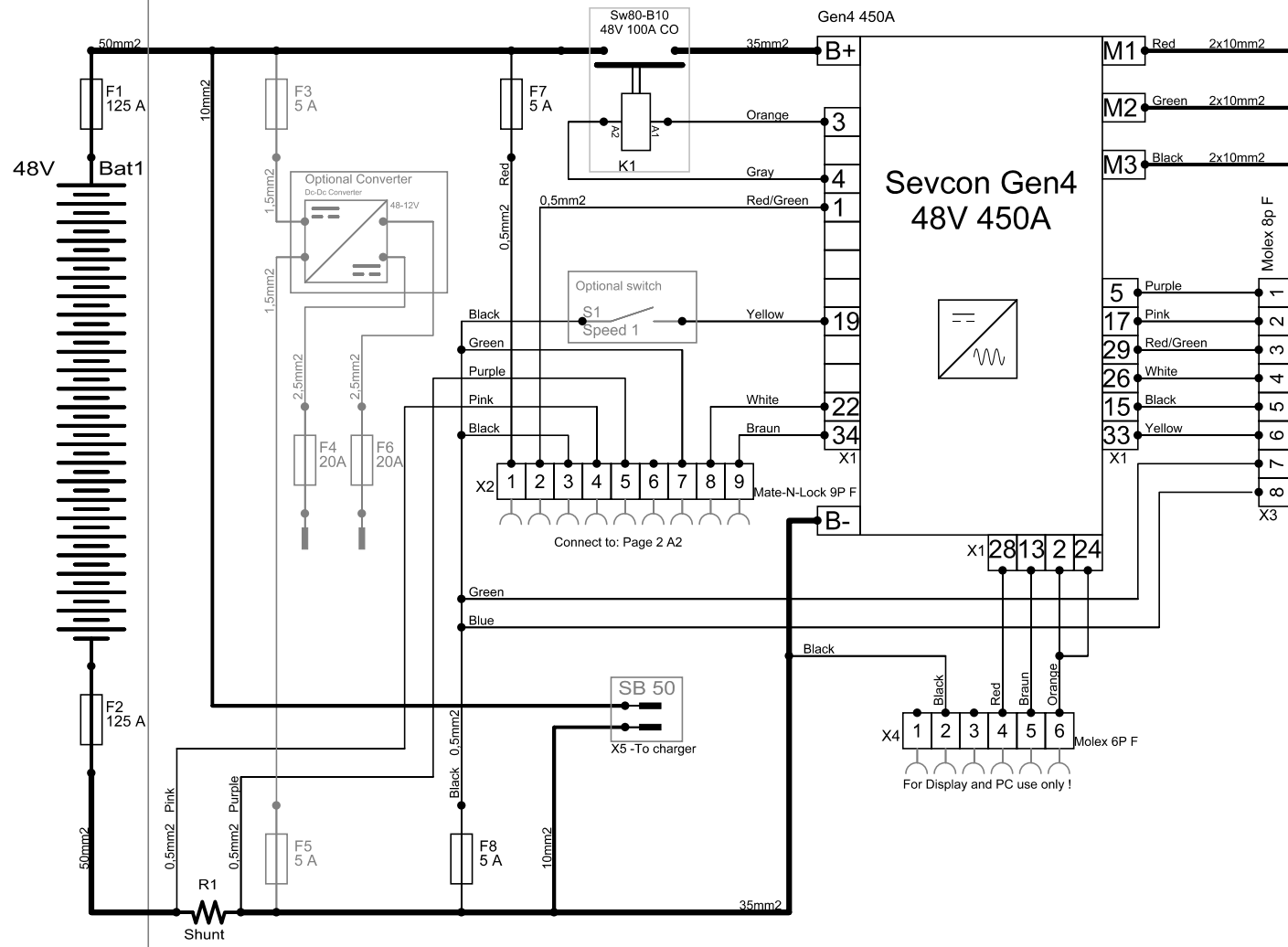
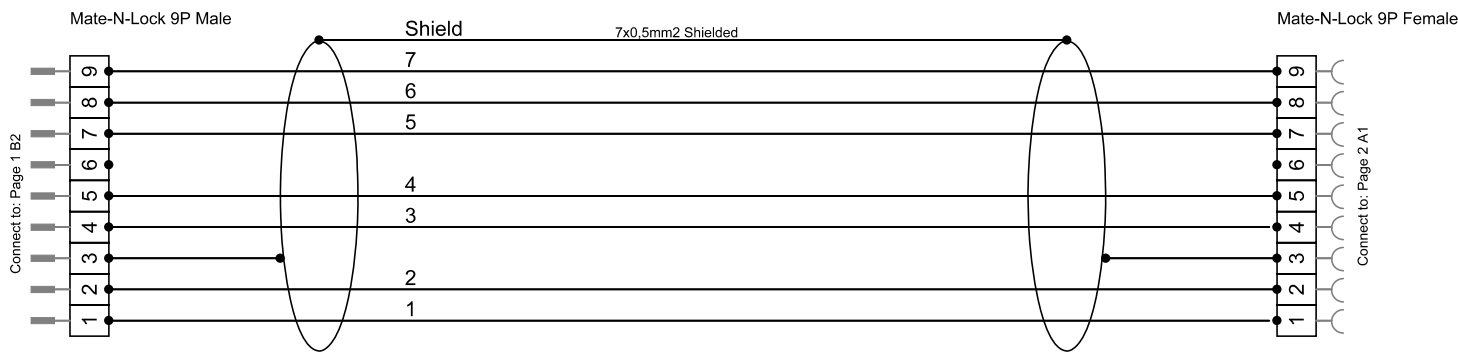
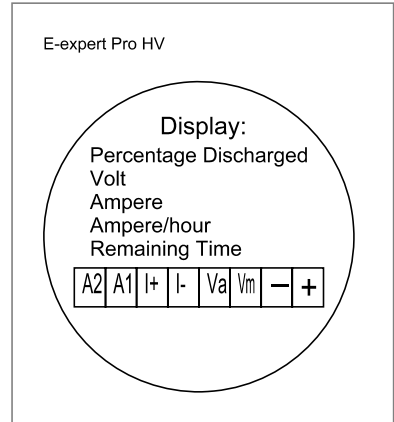
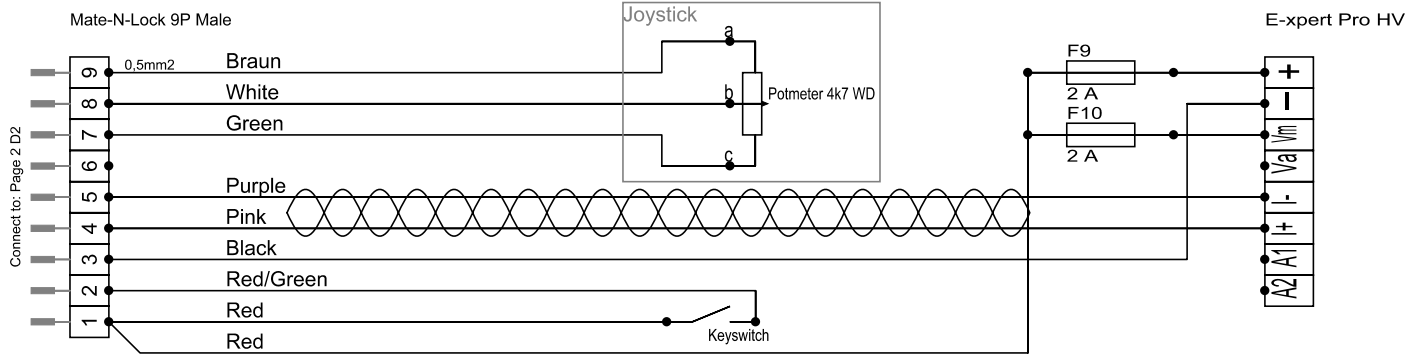

LED indicator Flashes	Fault:	Seriousness	Condition:	Checklist / Actions:
0	Internal or hardware fault	RTB	Hardware failsafe	Contact Dealer
1	Config fault	VS	Settings out off range	Contact Dealer
2	Startup fault	DI	Direction active on startup	Move joystick in neutral or check mecanical and wiring
3	Short circuit in motor cables	VS	Flooded motor or cable short circuit	Check motorcables
4	Line contactor fault	S	Line contactor welded or dirty	Check line contactor
5	No motor connected	S	No response on motor	Check motorcables
6	Joystick out off range	VS	Joystick settings or wrong joystick	Check joystick wiring and potmeter
7	Battery voltage high/low	S	Battery voltage To high/low or cable	Check battery and batterycables
8	Motor or controller temperature	I	Reduced power	Reduce power or reduce load an check propeller
10	Pre operational	I	Programming mode	Contact dealer
11	Encoder or Current fault	VS	No rotation detected	Check propeller and shearpin
12	Com error	S	No display possible	Check dispaywiring
13	Software damaged	RTB	Runtime error in software	Contact Dealer
Others	Settings out of range	RTB	No program running	Contact dealer

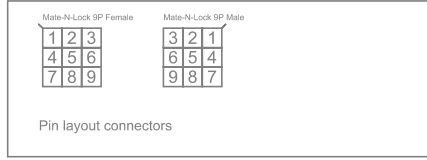

Electric scheme:
 Arka POD systems
 Type: APOD5000
 Page 2 of 2
 Rev: 10-01 2017
 H. Arendshorst

Arka

Electric propulsion systems